

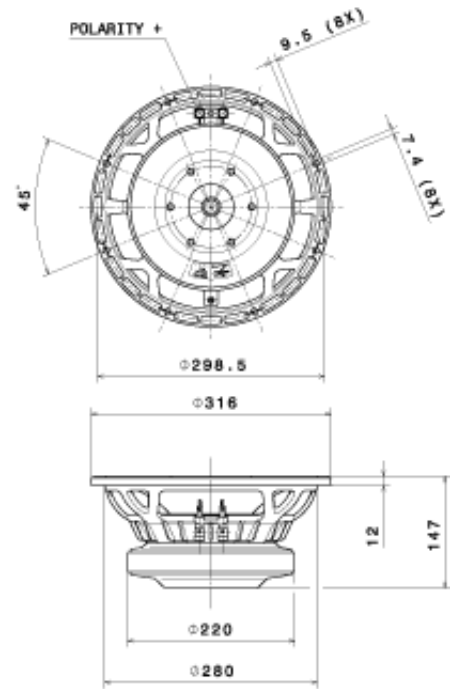

12HP1030 High Performance Series



NOMINAL SPECIFICATIONS

Nominal Diameter	300 mm (12 in)
Overall Diameter	316 mm (12.44 in)
Bolt Circle Diameter	298.5 mm (11.75 in)
Baffle Cutout Diameter	282 mm (11.10 in)
Depth	147 mm (5.79 in)
Flange and Gasket Thickness	12 mm (0.47 in)
Net Weight	11.1 Kg (24.55 lb)
Shipping Box (Single Carton Box)	350x346x190 mm (13.78x13.62x7.48 in)
Shipping Weight	11.6 Kg (25.57 lb)

ELECTRICAL SPECIFICATION

Nominal Impedance	8 Ohm
Minimum Impedance	6.7 Ohm
AES Power Handling *	1000 W
Maximum Power Handling **	2000 W
Sensitivity (1W/1m)	95 dB
Frequency Range	45÷1600 Hz
Voice Coil Diameter	100 mm (4 in)
Winding Material	Cu
Former Material	Glass Fiber
Winding Depth	28.9 mm (1.14 in)
Magnetic Gap Depth	12 mm (0.47 in)
Flux Density	1.1 T
Magnet	Ferrite Ring
Demodulation	Aluminum Ring
Suspension ***	Triple Roll

THIELE & SMALL PARAMETERS

Fs	45 Hz
Re	5 Ohm
Qes	0.31
Qms	13.75
Qts	0.3
Vas	29.44 dm ³ (1.04 ft ³)
Sd	469 cm ² (72.7 in ²)
Xmax ****	12.45 mm
Xdamage *****	20.5 mm
Mms	130.5 g
Bl	24.3 N/A
Le	1.35 mH
Mmd	124.7 g
Cms	0.09 mm/N
Rms	2.7 Kg/s
Eta Zero	0.85 %
EBP	145 Hz

NOTES

Spider Profile: 2x non-adjacent symmetrical variable height waves

(*) 2 Hours Test According to AES 2-1984 Rev. 2003

(**) Maximum power is defined as 3dB greater than nominal power.

(***) Treated Polycotton

(****) $X_{max} = [(winding\ depth - magnetic\ gap\ depth) / 2] + (magnetic\ gap\ depth / 3)$

(*****) Maximum excursion before permanent damage

CURVES

