

Poignées de transport

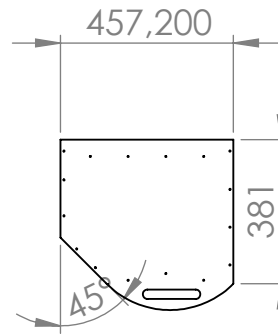

Emplacement RCF HF64 + ND650

Emplacement RCF L15P540

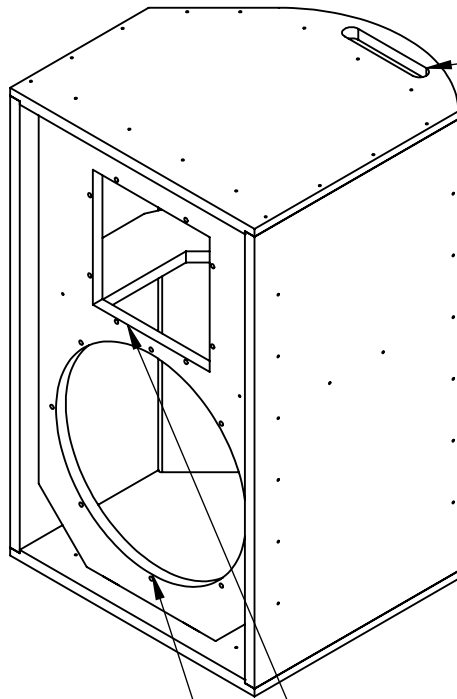
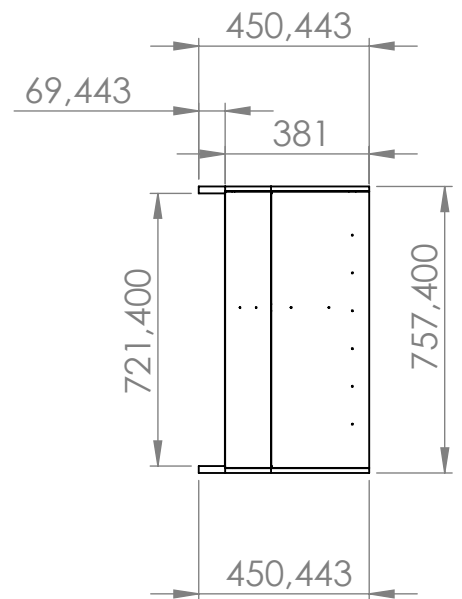
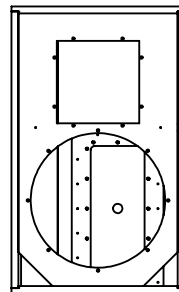
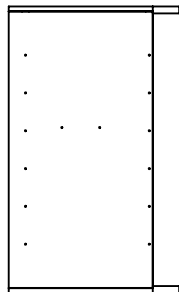
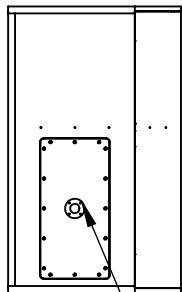

Pour intégration NL4MPR

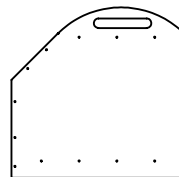

RCF CLUB15HP

Copyright La-Planche-de-Bois.fr
Toute reproduction, même partielle, est interdite sans l'autorisation écrite préalable du site.

Cotes en millimètres
Tolérance de fabrication : +/- 0.75 mm
Document format A4
Echelle 1:5 (et 1:10 en haut à droite)

