

GENERAL CHARACTERISTICS

Nominal Overall Diameter	210	mm
Nominal Voice Coil Diameter	65	mm
Magnet Weight	220	g
Flux Density.....	1.04	T
Weight.....	1.76	Kg

THIELE-SMALL PARAMETERS

Voice Coil DC Resistance	R_E	3.21	Ω
Resonance Frequency	f_s	62.2	Hz
Mechanical Q Factor.....	Q_{MS}	2.35	
Electrical Q Factor.....	Q_{ES}	0.34	
Total Q Factor	Q_{TS}	0.30	
Mechanical Moving Mass	M_{MS}	24.5	g
Mechanical Compliance	C_{MS}	267	μm/N
Force Factor	$B \times l$	9.49	Wb/m
Equivalent Acoustic Volume.....	V_{AS}	17.2	lt.
Maximum Linear Displacement	X_{MAX}	+/-4.0	mm
Reference Efficiency	η_0	1.16	%
Diaphragm Area	S_D	213.8	cm ²
Losses Electrical Resistance.....	R_{ES}	22.0	Ω
Voice Coil Inductance @ 1kHz	L_E	0.82	mH

CONSTRUCTIVE CHARACTERISTICS

Magnet.....	Neodymium
Voice Coil Winding.....	Aluminium
Voice Coil Former.....	Kapton
Cone	Paper
Surround.....	Treated Cloth
Dust Dome	Solid Paper
Basket	Aluminium Die-Cast

ELECTRICAL CHARACTERISTICS

Nominal Impedance.....	4	Ω
Musical Power	500	W
Rated Power*	250	W
Sensitivity @ 1 W, 1 m	93.8	dB

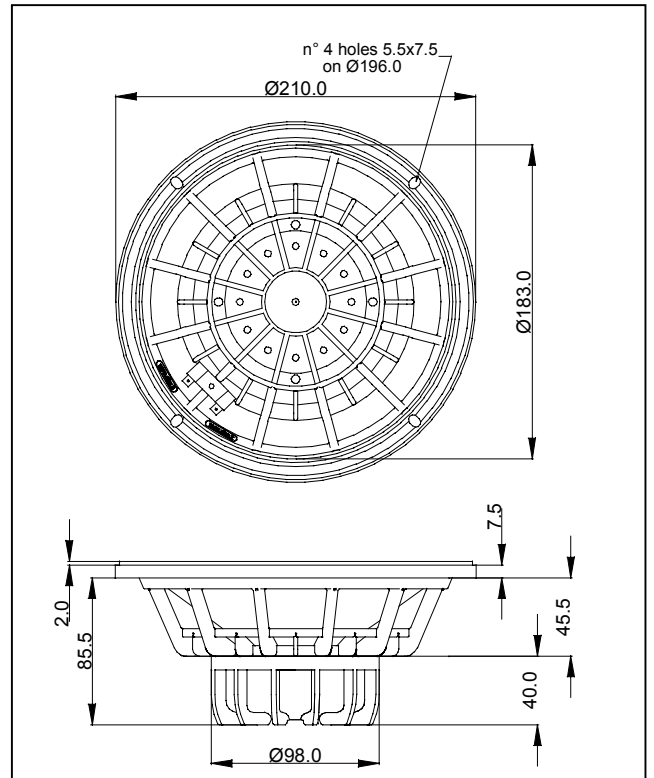

*rated power measured with 2 hours test with pink noise signal, 6 dB crest factor, loudspeaker mounted on enclosure
Thiele-Small parameters measured with LASER system

Frequency Response on IEC Baffle (DIN 45575) @ 1 W, 1 m - Impedance

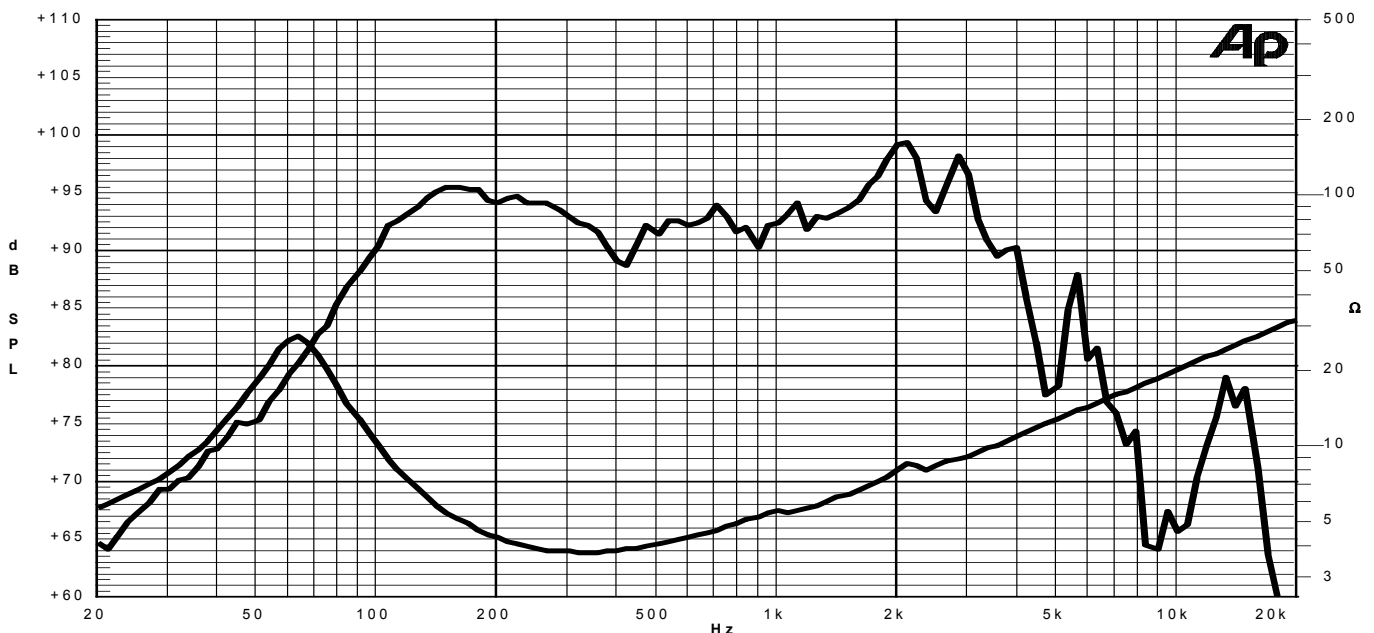

Due to continuing product improvement, the features and the design are subject to change without notice.

11/03/10