

- 3" sandwich voice coil fiberglass former
- Progressive wave Konex spider with DCS technology
- Rubber surround with DAR technology
- Waterproof cone treatment
- High excursion ferrite magnet circuit
- Ventilated magnet and voice coil to reduce power compression
- 92.0 dB sensitivity

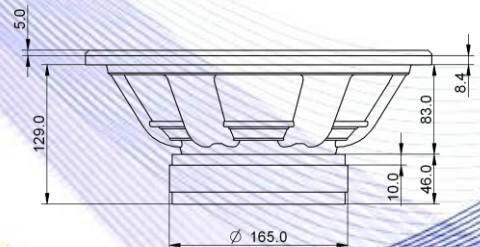
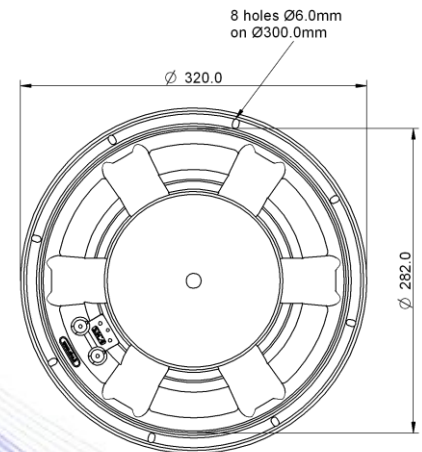

Specifications	
Nominal Diameter	321mm (12")
Nominal Impedance	4Ω
Rated Power AES <sup>(1)</sup>	350W
Continuous Program Power <sup>(2)</sup>	700W
Sensitivity @ 1W/1m <sup>(3)</sup>	92.0dB
Voice Coil Diameter	75mm (3")
Voice Coil Winding Depth	20mm
Magnetic Gap Depth	10mm
Flux Density	0.95T
Magnet Weight	1790g
Net Weight	7.3kg

Thiele & Small Parameters <sup>(4)</sup>			
Re	3.12Ω	Fs	37.3Hz
Qms	3.31	Qes	0.39
Qts	0.35	Mms	105.7g
Cms	172μm/N	Bxl	13.99Tm
Vas	58.6l	Sd	490.9cm <sup>2</sup>
X max <sup>(5)</sup>	+/-5.5mm	X var <sup>(6)</sup>	+/-8.2mm
η <sub>0</sub>	0.74%	Le (1kHz)	0.90mH

Constructive Characteristics	
Magnet	: Ferrite
Basket Material	: Aluminium Die-Cast
Voice Coil Winding Material	: Copper
Voice Coil Former Material	: Fiberglass
Cone Material	: Paper
Cone Treatment	: Surface Waterproof Treatment
Surround Material	: Rubber
Dust Dome Material	: Solid Paper

Frequency Response on IEC Baffle (DIN 45575) @ 1W,1m – Free Air Impedance

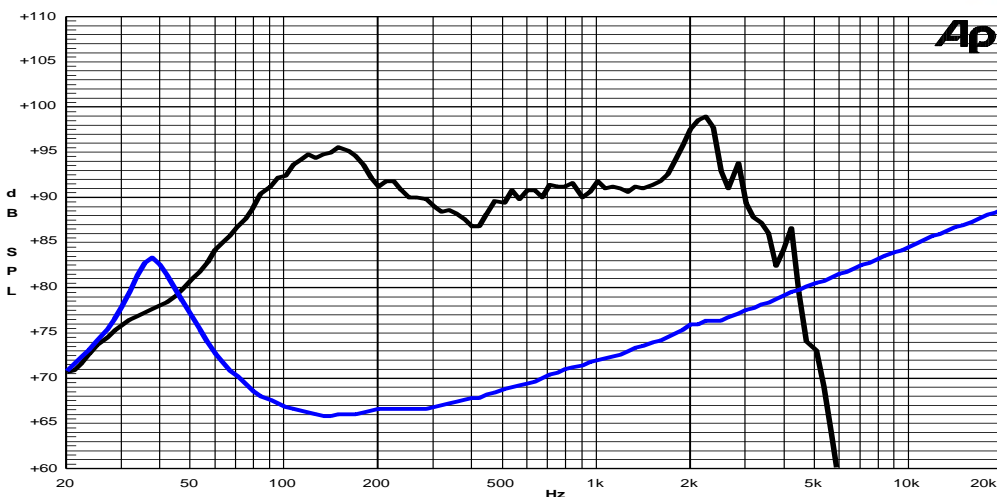

- Note:
- 1 : Rated Power measured with 2 hours test with pink noise signal, 6dB crest factor, loudspeaker mounted on enclosure
  - 2: Power on Continuous Program is defined as 3 dB greater than the Rated Power
  - 3: Calculated by Thiele & Small parameters
  - 4: Thiele & Small parameters measured with laser system without preconditioning test
  - 5: Measured with respect to a THD of 10% using a parameter-based method
  - 6: Value corresponding to a decay of the Force Factor, or Compliance, or both, equal to the 50% of the small signal value.
  - 7: Drawing dimensions: mm
  - 8: The notch around 400Hz on the frequency response is typical of the measurement on IEC baffle

Due to continuing product improvement, the features and the design are subject to change without notice.

30/10/19