

15" - 500W Bass Guitar Loudspeaker

15 BS 2,5 PL - 8 Ω

Code Z008151

GENERAL CHARACTERISTICS

Nominal Overall Diameter	388	mm
Nominal Voice Coil Diameter	65	mm
Magnet Weight	220	g
Flux Density.....	1.14	T
Weight.....	3.00	Kg

THIELE-SMALL PARAMETERS

Voice Coil DC Resistance	R_E	5.32	Ω
Resonance Frequency	f_s	44.0	Hz
Mechanical Q Factor.....	Q_{MS}	11.59	
Electrical Q Factor.....	Q_{ES}	0.58	
Total Q Factor	Q_{TS}	0.56	
Mechanical Moving Mass	M_{MS}	84.5	g
Mechanical Compliance	C_{MS}	150	μm/N
Force Factor	$B \times l$	14.58	Wb/m
Equivalent Acoustic Volume.....	V_{AS}	160.4	lt.
Maximum Linear Displacement	X_{MAX}	+/-5.0	mm
Reference Efficiency	η_0	2.24	%
Diaphragm Area	S_D	855.3	cm ²
Losses Electrical Resistance.....	R_{ES}	105.4	Ω
Voice Coil Inductance @ 1kHz	L_E	1.03	mH

CONSTRUCTIVE CHARACTERISTICS

Magnet.....	Neodymium
Voice Coil Winding.....	Copper
Voice Coil Former.....	Kapton
Cone	Paper
Surround.....	Treated Cloth
Dust Dome	Solid Paper
Basket	Aluminium Die-Cast

ELECTRICAL CHARACTERISTICS

Nominal Impedance.....	8	Ω
Musical Power	500	W
Rated Power*	250	W
Sensitivity @ 1 W, 1 m	97.5	dB

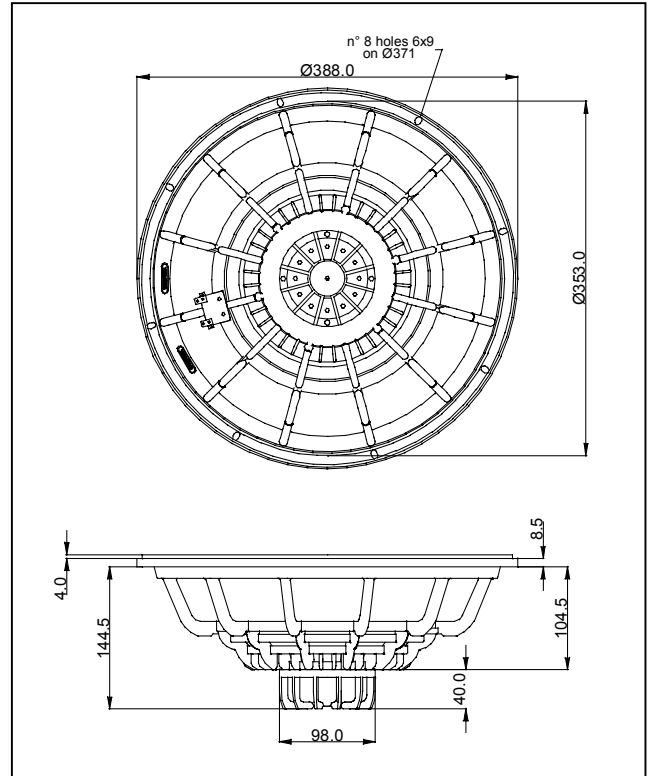

*rated power measured with 2 hours test with pink noise signal, 6 dB crest factor, loudspeaker mounted on enclosure
Thiele-Small parameters measured with LASER system

Frequency Response on IEC Baffle (DIN 45575) @ 1 W, 1 m - Impedance

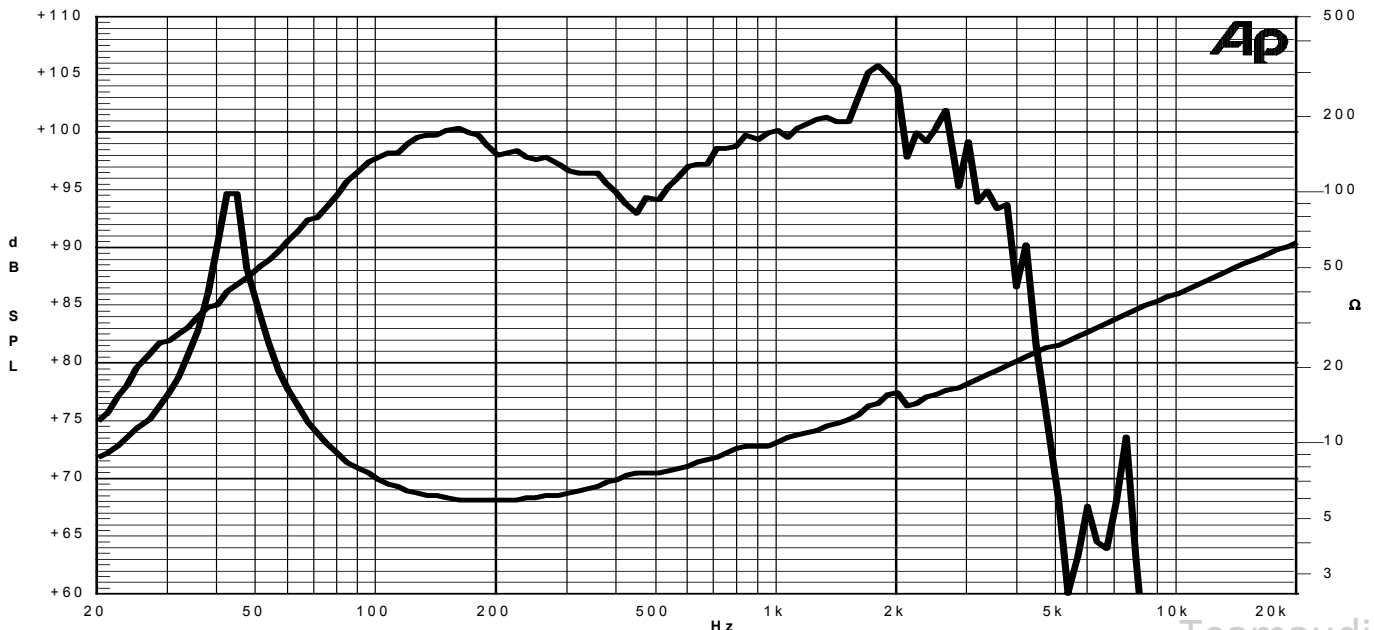

Due to continuing product improvement, the features and the design are subject to change without notice.

23/09/08

15 BS 2,5 PL

15" speaker – 2,5" voice coil

GRAPHICS AND MEASUREMENTS

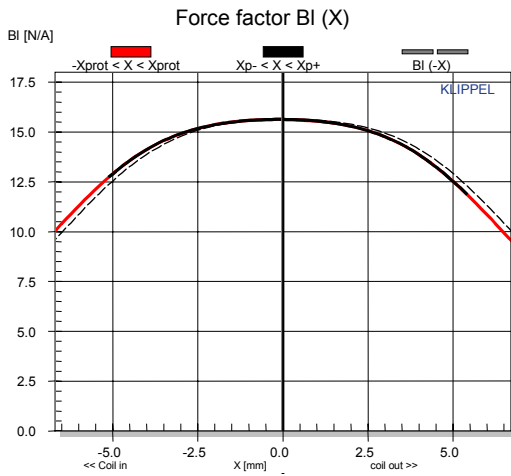

BI(X): force factor variation with voice coil displacement

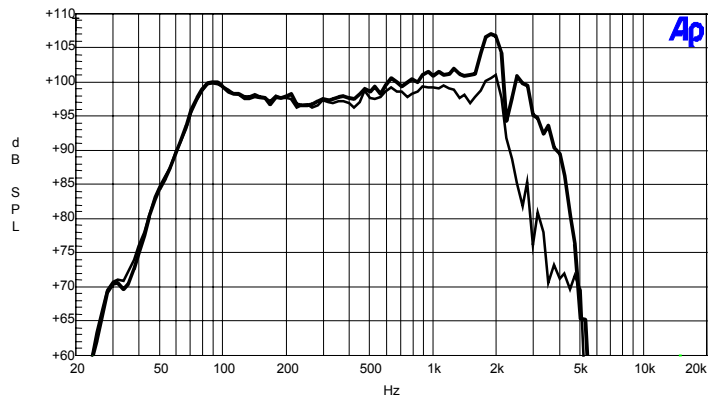

Frequency Response: enclosure volume 80l, port tuning 58Hz (thick curve on axis, thin curve 30° off axis)

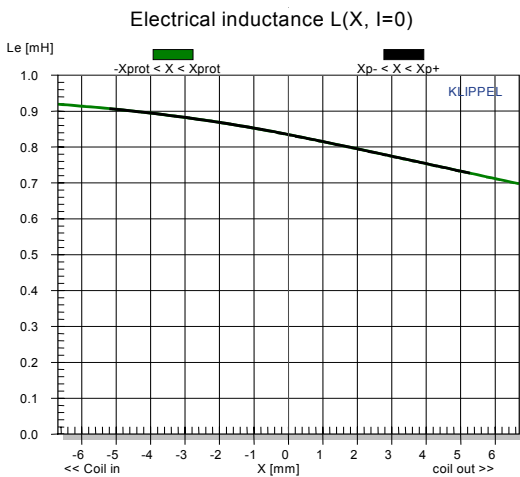

Le: electrical inductance variation with voice coil displacement

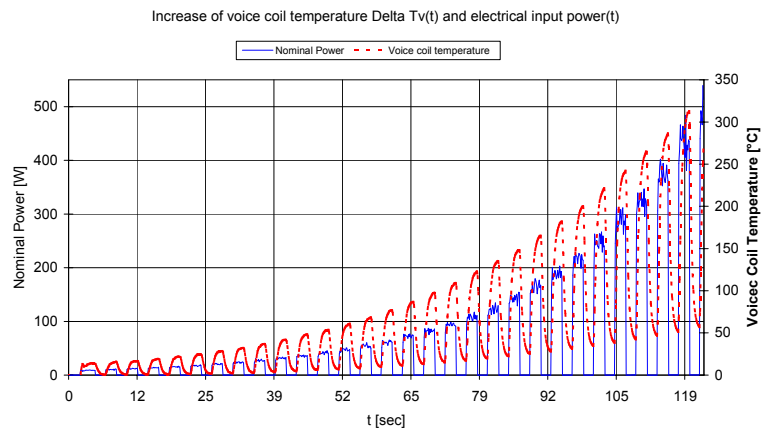

Power test done with intermittent excitation, ON interval 2min, duty cycle 50%, pink noise signal 6dB crest factor with frequency range 50-2000Hz.

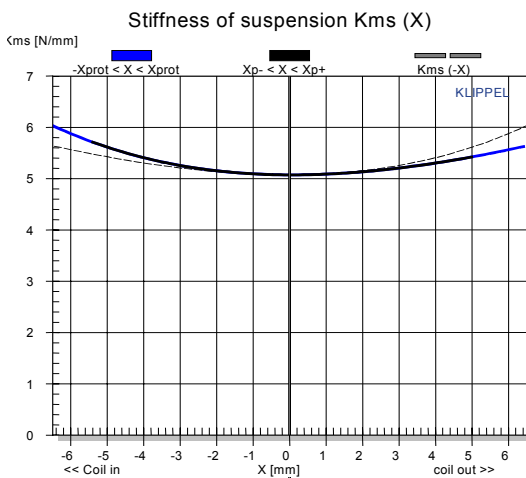

K_{ms}: stiffness of suspension variation with voice coil displacement

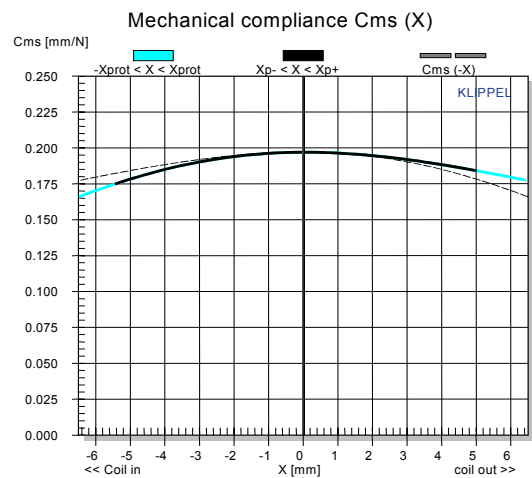

C_{ms}: mechanical compliance variation with voice coil displacement