

Kit enceinte TLHP PunchLine-10

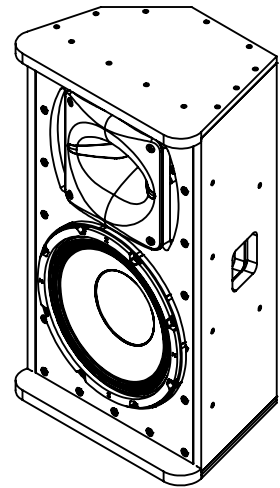

Pieds caoutchoucs de support

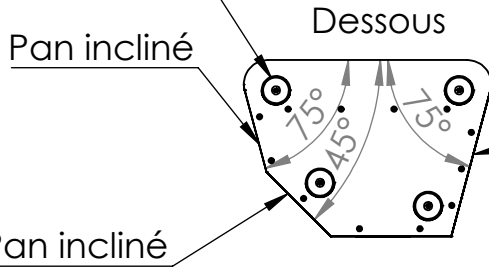

Pan incliné

Moteur d'aigu
Sica CD83.26/380
avec pavillon H1-7050 Nobell

Poignée latérale

Event bass-reflex

Double bornes Neutrik NL4MP

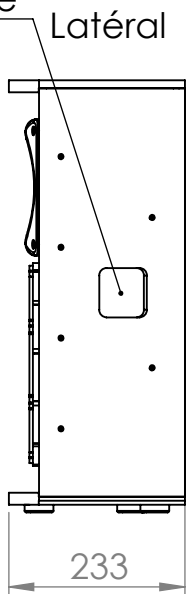

Face avant

Latéral

Arrière

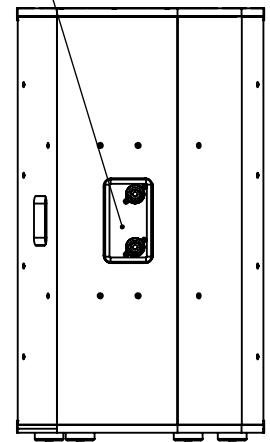
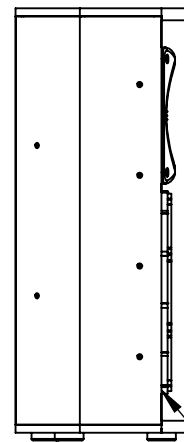
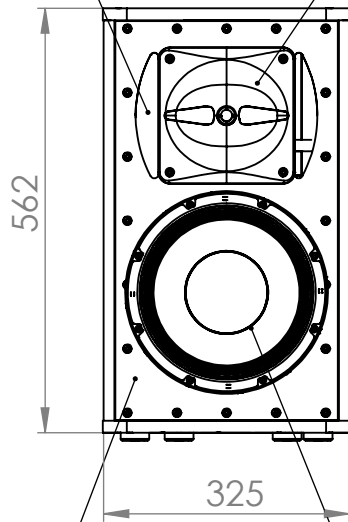

Façade avant prête pour montage option KIT-GRILLE-ST05

Façade avant amovible

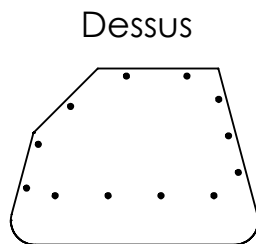

Haut-parleur Sica 10F2.5CP-8

K-PL-10

Cotes en millimètres
Tolérance de fabrication : +/- 0.25 mm
Document format A4